

# MESA DAY 2019

## Craft-stick Bridge Contest

**Level:** Elementary/Grades K-5  
Middle School/Grades 6-8  
High School/Grades 9-12

**Teams:** 2 students per team.

**Overview:** To use math and science to implement engineering concepts in the design and construction of a model bridge from your own plans that will carry a maximum load while using as few craft-sticks as possible; and, to develop neatness, craftsmanship and creativity.

**Materials:**

1) Only un-dyed, untreated, natural wood craft-sticks (e.g. popsicle sticks) with the following approximate dimensions may be used:

Length = 11.4cm (4.5 in.)

Width = 0.95cm (3/8 in.)

Thickness = 0.2cm (1/16 in.)

2) Maximum number of sticks allowed is:

a) 200 sticks for Elementary

b) 150 sticks for Middle School

c) 100 sticks for High School

3) Only water-soluble white glue is allowed.

4) Sticks may be cut, however the lamination rule will be applied to each piece individually.

## Construction Specifications

1. Length 33 to 43 cm
2. Width 10 to 14 cm
3. Maximum height above Roadway 16 cm
4. Maximum depth below Roadway 10 cm
5. Minimum width of open Roadway (running entire length of bridge) 10 cm

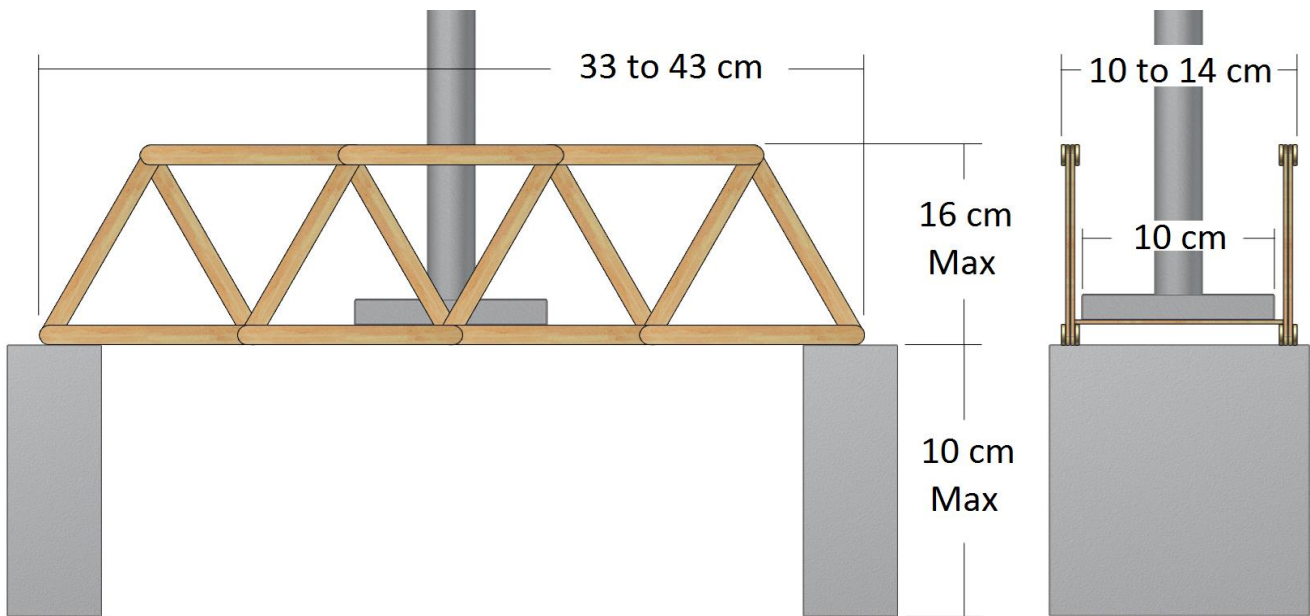

6. A maximum of 50% of a craft-stick's total flat surface may be covered by glue (laminated). Both sides of each stick can be considered in the 50% calculation. Sticks can be cut and sanded.

**\*\*The images below are side views of a popsicle stick.\*\***

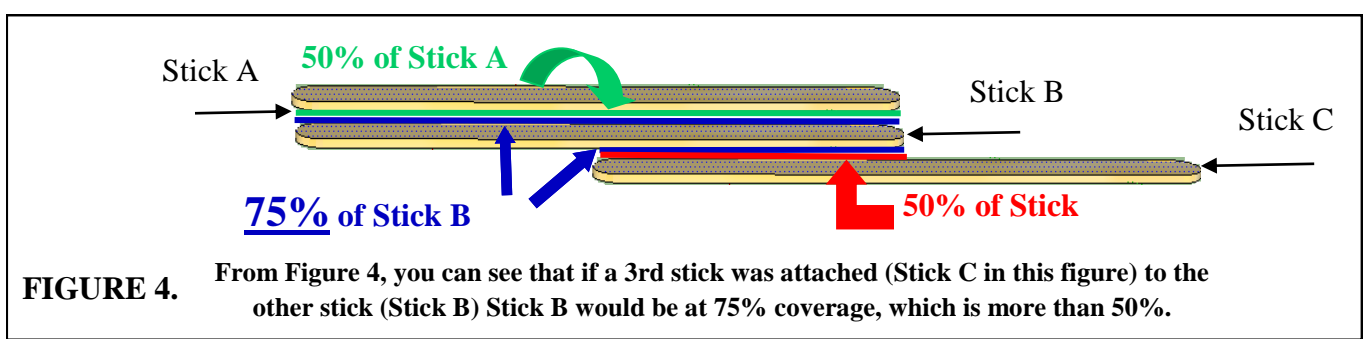
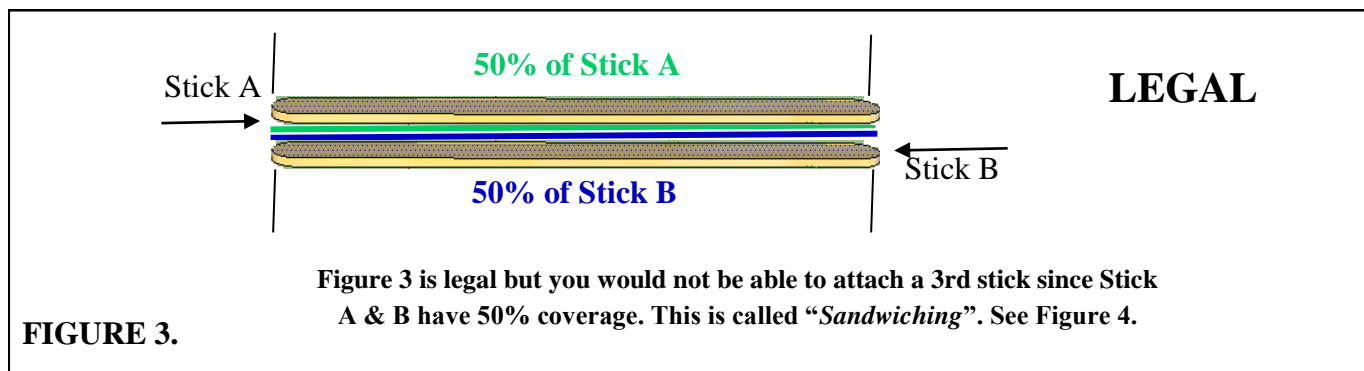
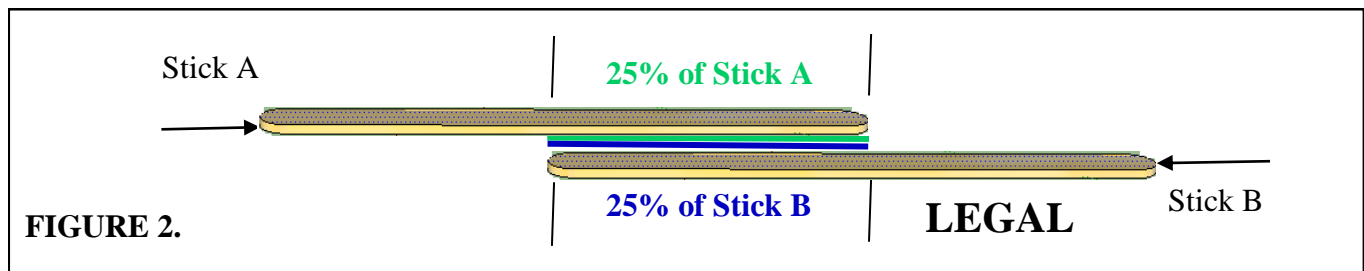
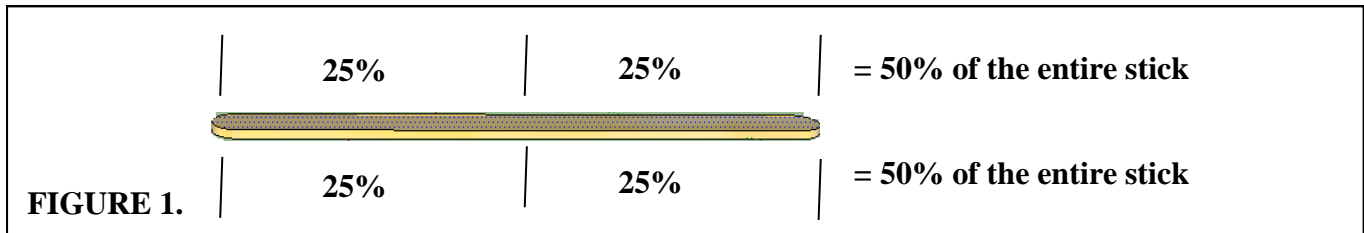

7. Glue (water soluble white glue) must be used at the joints only.
8. No coatings of any kind, including glue, paint, cement, epoxy, etc. may be applied to any surface of the bridge. Bridge will be disqualified if it is coated with any substance. Markers and Pencils are acceptable.
9. Bridge must have a clear and unobstructed roadway at least 10 cm wide, running the full length of the bridge, as if automobile traffic were going to cross it.
10. Joints can be constructed using any method other than notching or pinning.

**Acceptable Joints**

**Butt Joints - the end of one stick butts up to end of another**

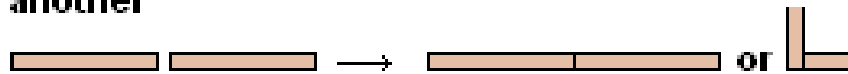

**Miter Joints - the ends of the sticks are cut an angle (usually 45 degrees) and the angled cuts are butted up to one another**

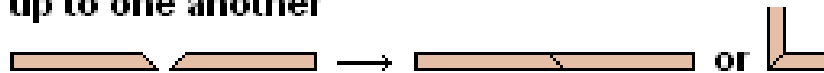

**Gusset - a triangular plate used for strengthening or reduction of torsion**



**Un-Acceptable Joints**

**Pinned Joints**



**Pinned Joints are made by cutting small holes in each craft stick so that can be fastened together by a third object such as a nail.**

**Notched Joint**



**Notched Joints - the ends of the sticks have slits or notches cut into them and the notched ends slide together so that the sticks overlap.**

### **Specifications Check:**

1. Bridge is examined and measured by the judges to check whether it conforms to contest rules and specifications.
2. Any bridge that does not meet the requirements will be disqualified.
3. Bridge is weighed and its weight recorded. A maximum weight of 310 grams (200 craft sticks plus 10% for glue) is allowed for elementary, 230 for Middle School and 155 for High School. Bridges over the maximum weight will be disqualified.

### **Judging:**

1. The maximum load recorded by the load testing machine will be used as the load capacity of the bridge, regardless of when failure begins.
2. Disqualified bridges are not eligible for awards; however, they may be tested, if time permits.
3. Lamination Rule Score Deduction
  - Bridges who do not follow the lamination rule consistently will be deducted points from their total score.

Number of Infractions	1 - 5	6 - 10	11 - 15	16+
Point Deduction	10% of total score	15% of total score	30% of total score	50% of total score

### **Awards:**

1<sup>st</sup>, 2<sup>nd</sup>, and 3<sup>rd</sup> place awards will be given to the bridges with the greatest load bearing capacity for each grade level.

**Safety:** Appropriate safety measures will be used during testing.